

VICINITY WHITEBOARD PAINT



VICINITY

Installation Guidelines



Components

Installation Kit

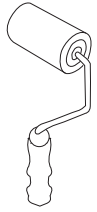

Cutting-In Roller

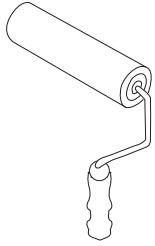

Filling-In Roller



Aerated Stir Stick

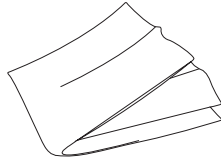

Drop Sheet

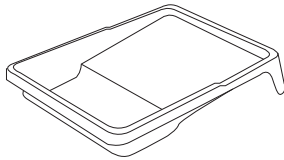

Paint Tray

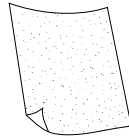

Sand Paper

Preparation



Universal Undercoat

Whiteboard Paint

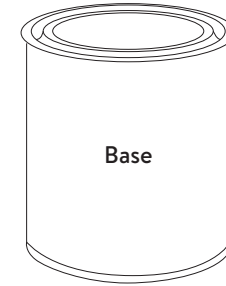

Base Tin



Activator Tin

Accessory Kit

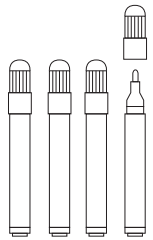

4 x Marker Pens



Microfibre Cleaning Cloth

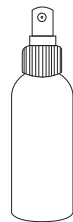

Water Spray Bottle

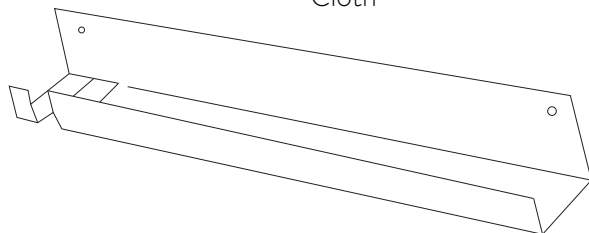

Pen Tray

Required but not provided

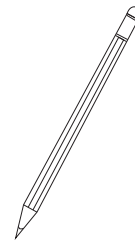

Pencil

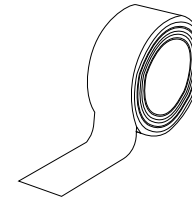

Masking Tape

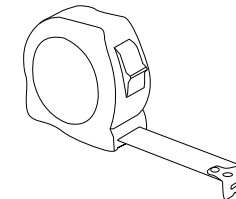

Tape Measure

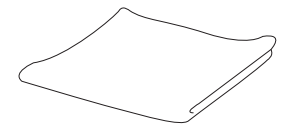

Cleaning Cloth

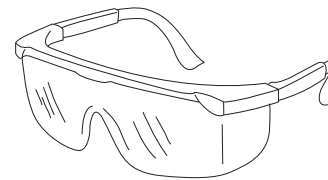

Protective Eyewear

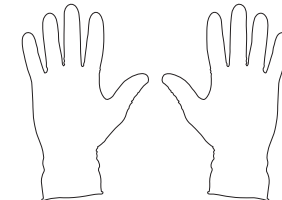

Protective Gloves

Safety Precautions

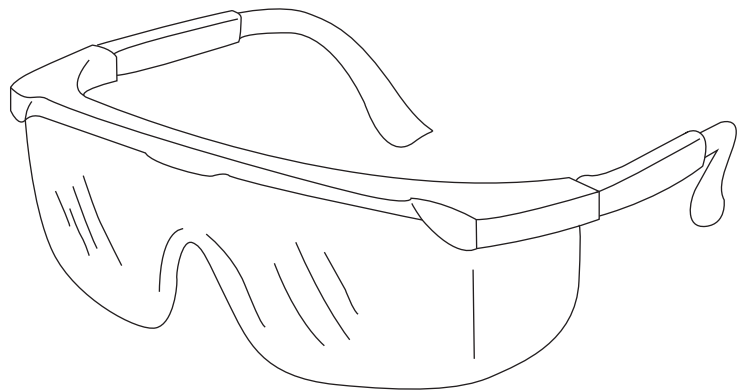

Wear protective glasses at all times.

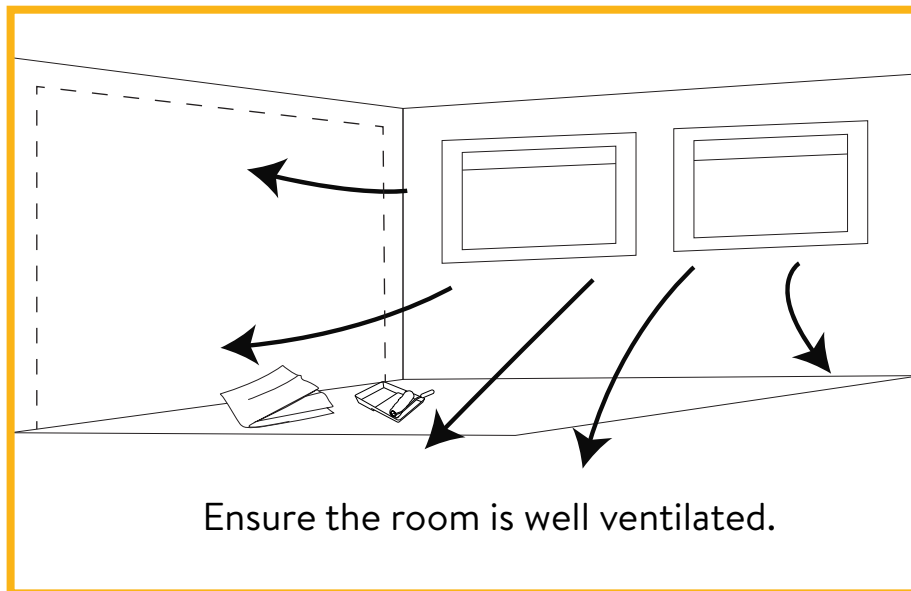

Ensure the room is well ventilated.

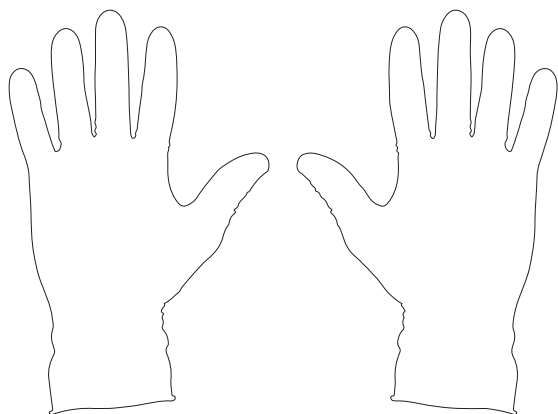

Wear protective gloves at all times.

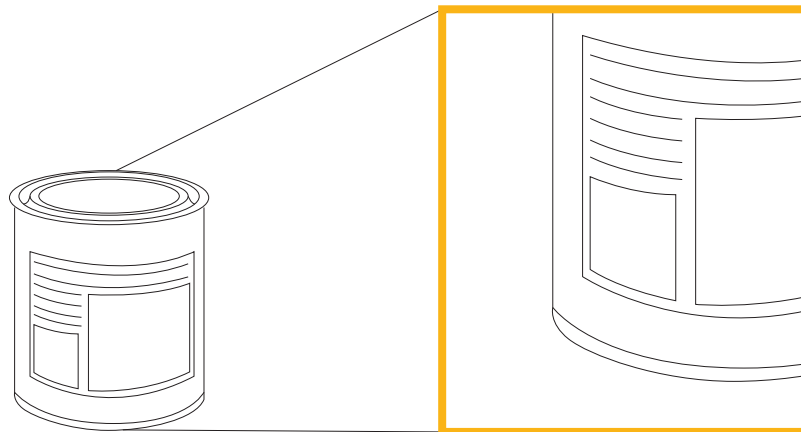

Refer to safety information on tin label.

Step 1: Site Preparation

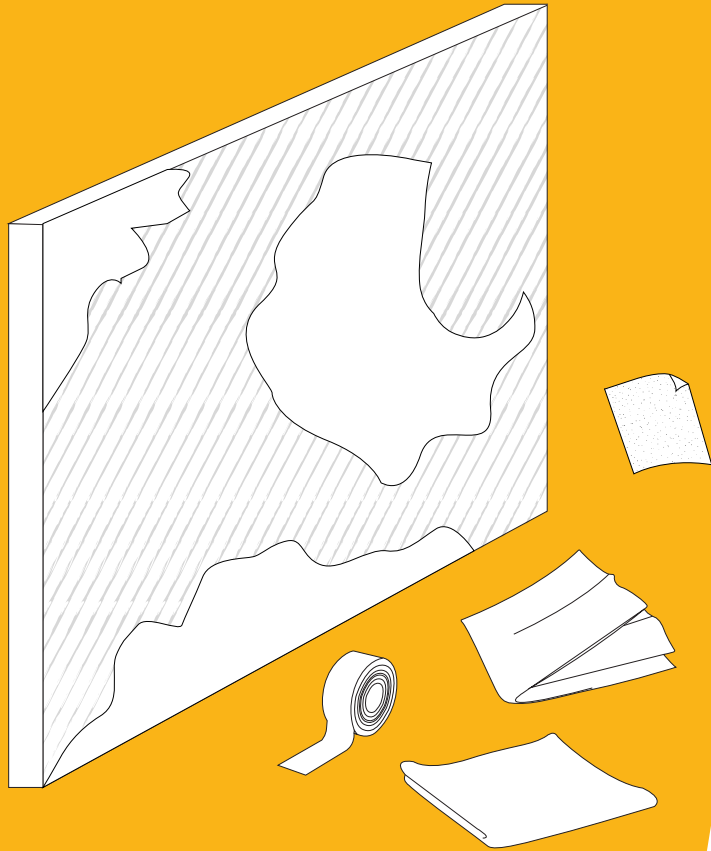

Process Comments

Prepare wall for paint and repair wall defects

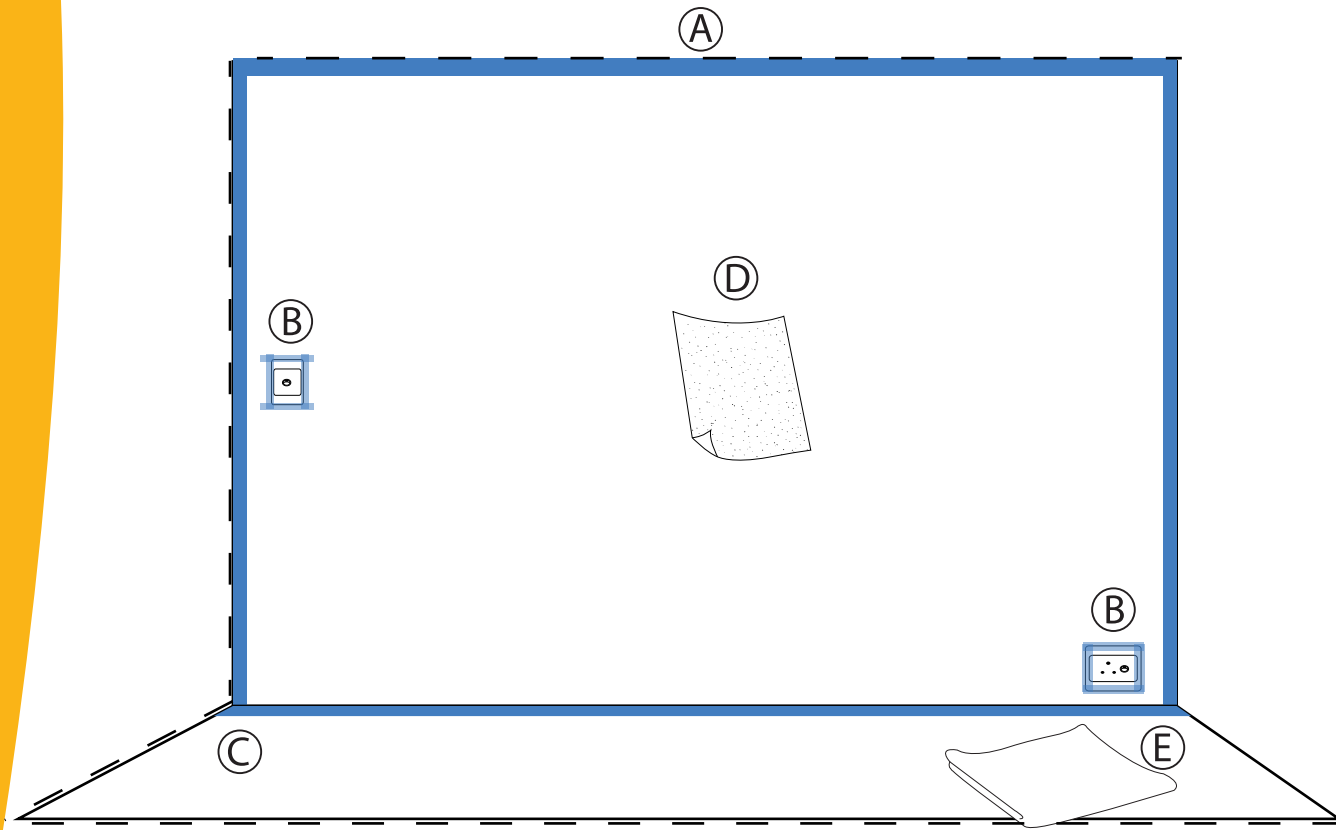

- (A) Tape off area that is to be prepared for whiteboard paint.
- (B) Tape off edges plug points and light switches.
- (C) Lay down drop sheet.
- (D) Sand and repair problem areas of wall.
- (E) Wipe down wall with damp cloth to remove dust and give time to dry before application.

Step 2: Apply Preparation Paint



Process Comments

Apply universal undercoat until wall is white. Dark colours may require multiple coats.

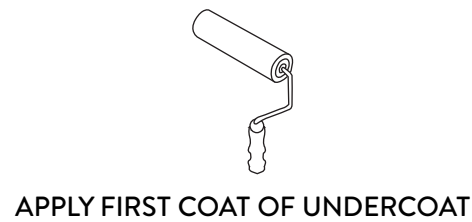

ALLOW UNDERCOAT TO DRY BETWEEN COATS

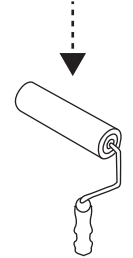

REPEAT UNTIL THE WALL IS WHITE



WASH INSTALL EQUIPMENT AFTER USE



ALLOW UNDERCOAT TO DRY FOR 24 HOURS BEFORE WHITEBOARD PAINT APPLICATION

TIP

Un-primed Wall

Apply single coat of Universal Undercoat to prime the wall, and repeat until white.

TIP

Other Surfaces such as Glass, Steel, Wood etc...

Apply specialised surface primer designed for the substrate before applying the Vicinity Universal Undercoat. It is advised to test a small sample before installing your project.

Step 3: Mark Out Surface Area

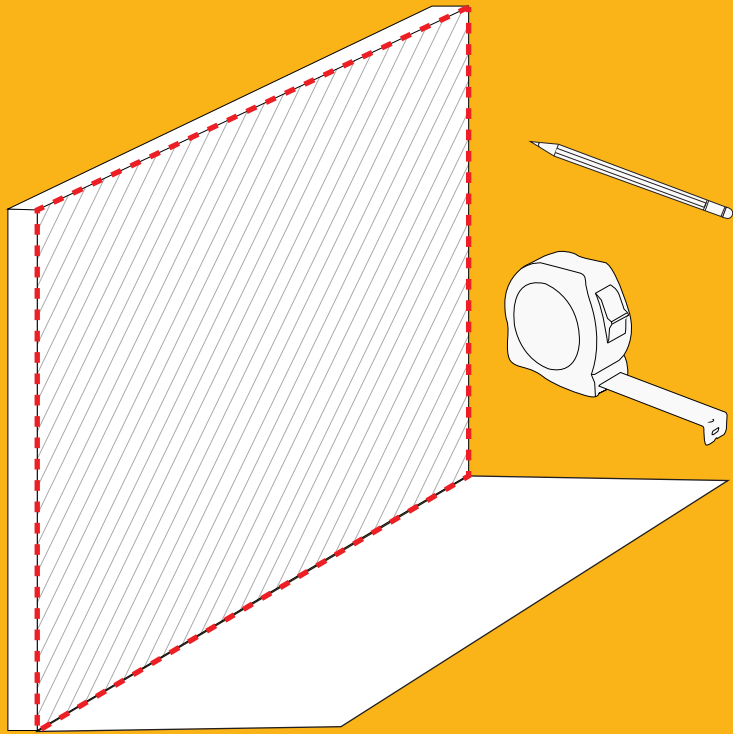

Process Comments

Measure and mark out the whiteboard paint area that corresponds with tin size you are opening

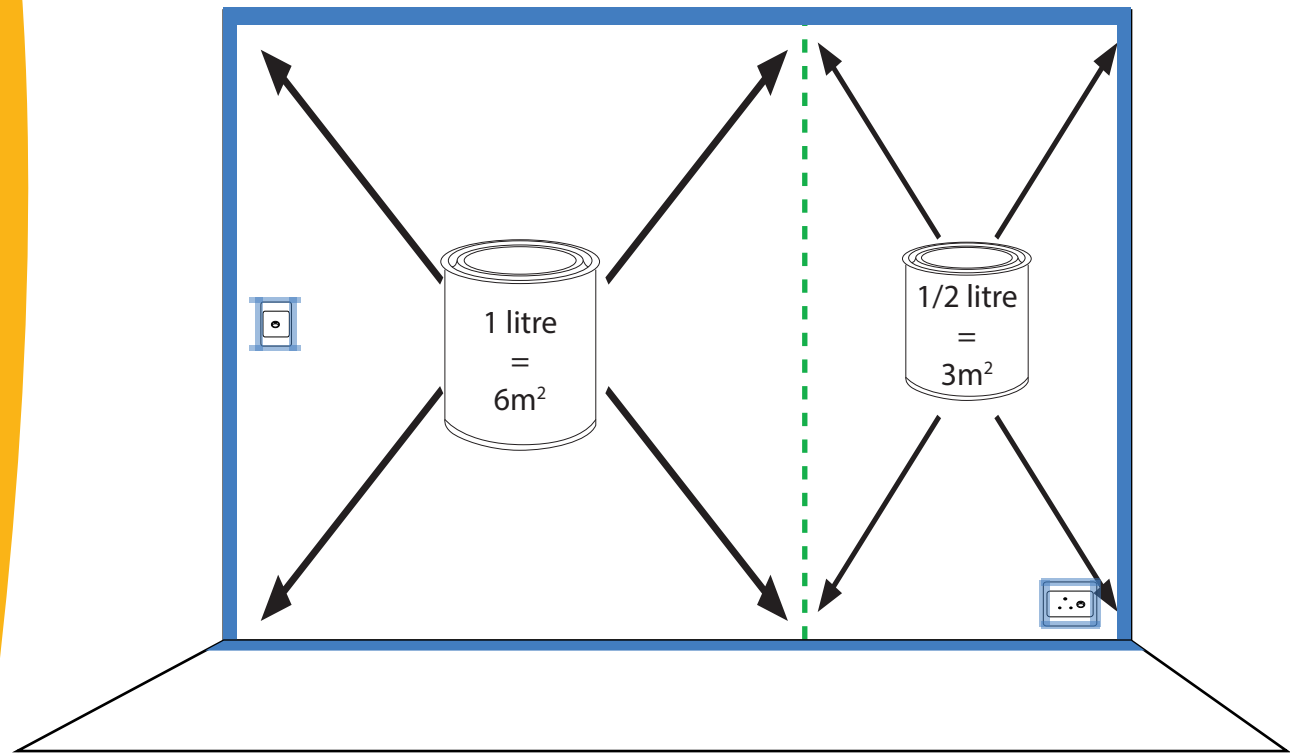

DO NOT STRETCH THE PAINT BEYOND THE SQUARE METER COVERAGE SPECIFIED

Step 4: Mixing Whiteboard Paint



① Open tins

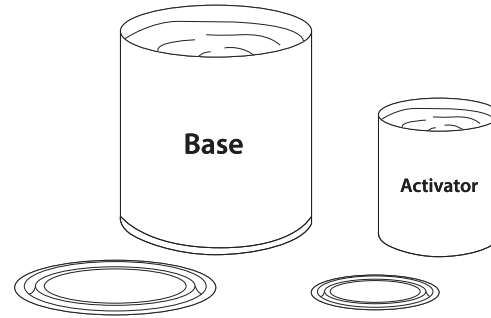

② Pour activator into base

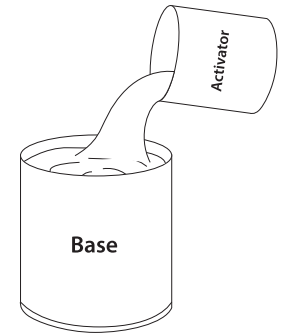

③

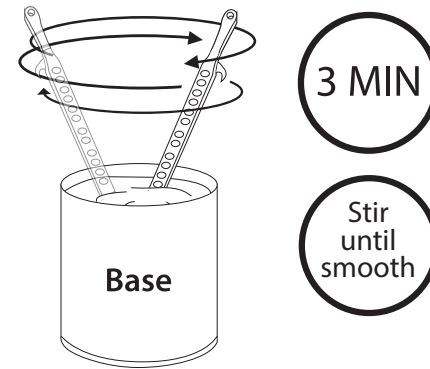

④

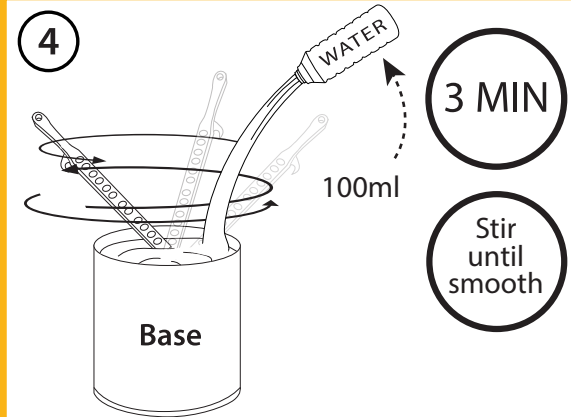

⑤

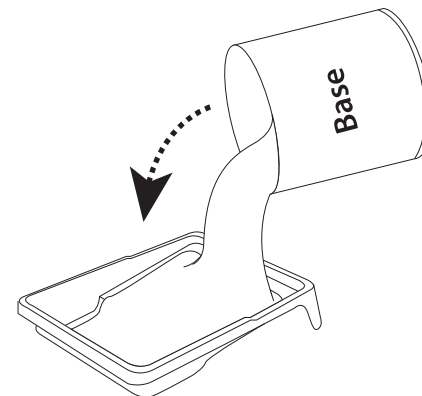

! USE WITHIN
1 HOUR
OF OPENING

Process Comments

Mixing the tins activates the paint. Adding water thins the paint for a smoother application.

Step 5: Apply Whiteboard Paint

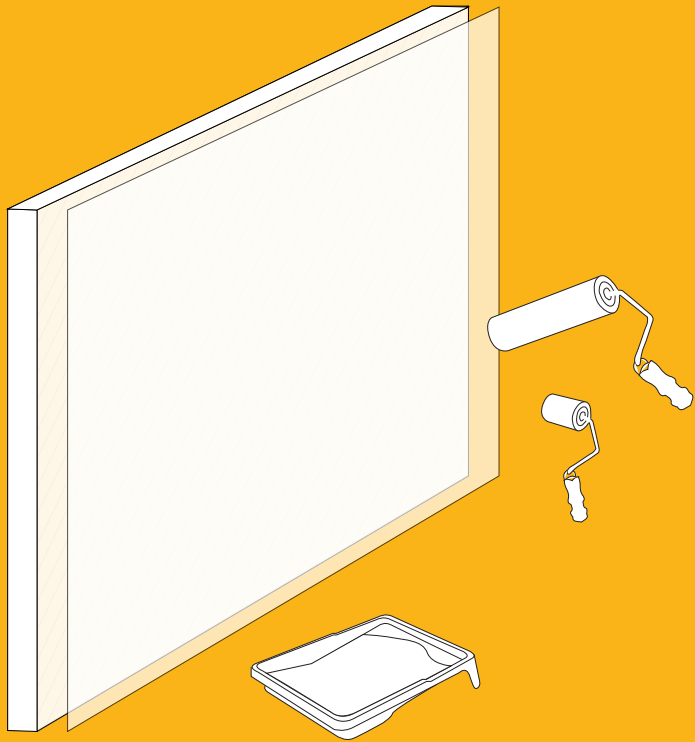

Process Comments

Cut-in 1 meter segments to prevent cut-in areas from drying before being filled in

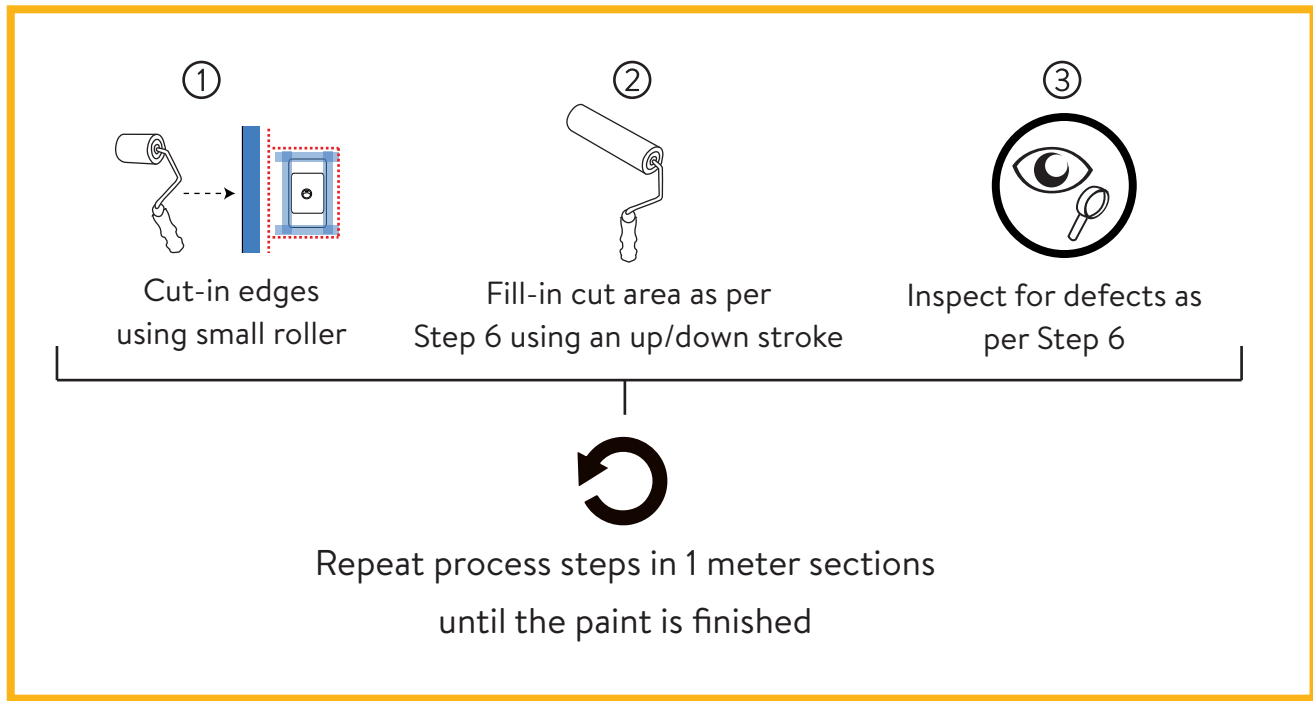
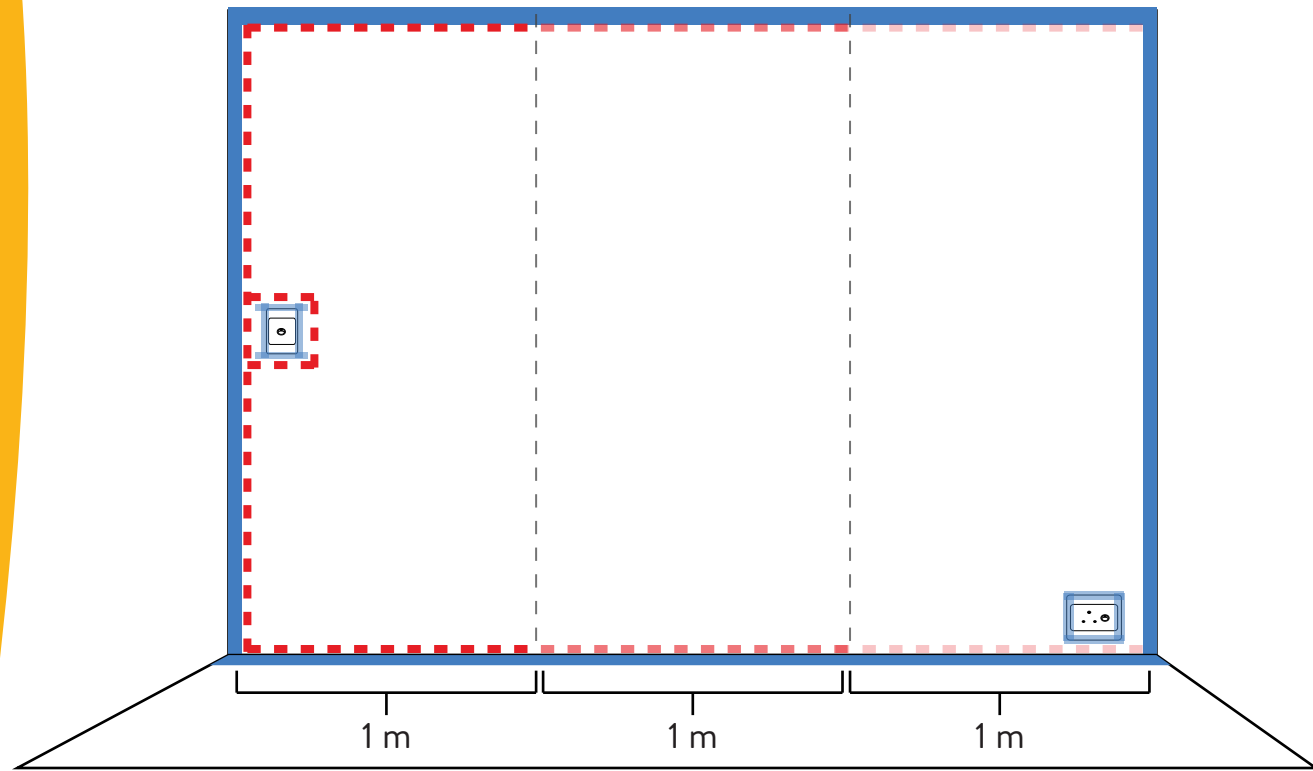

Step 6: Application Process Tips

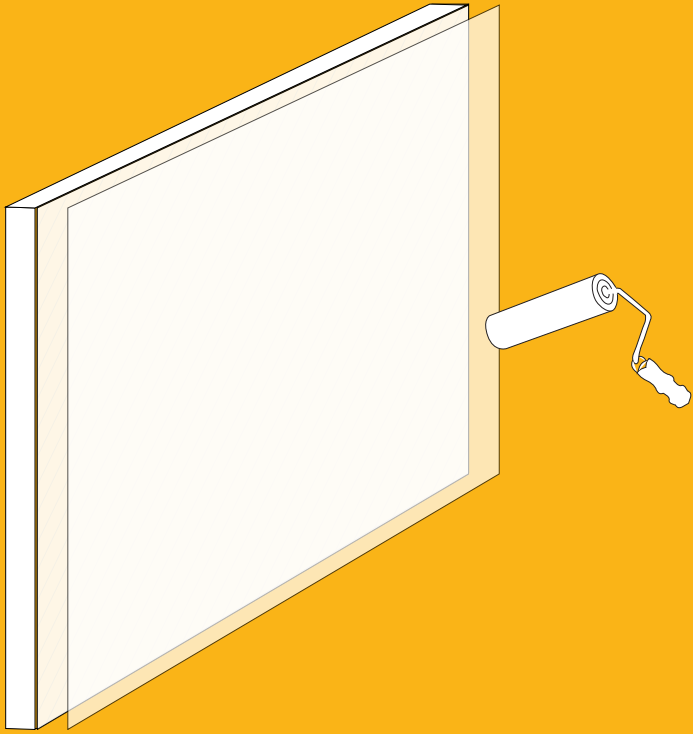

Process Comments

Apply the paint consistently and meticulously, and take your time to ensure a high quality finish.

TIP

Apply paint in a up/down direction
blending each
section as you go.

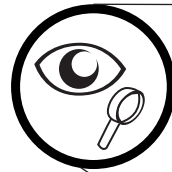
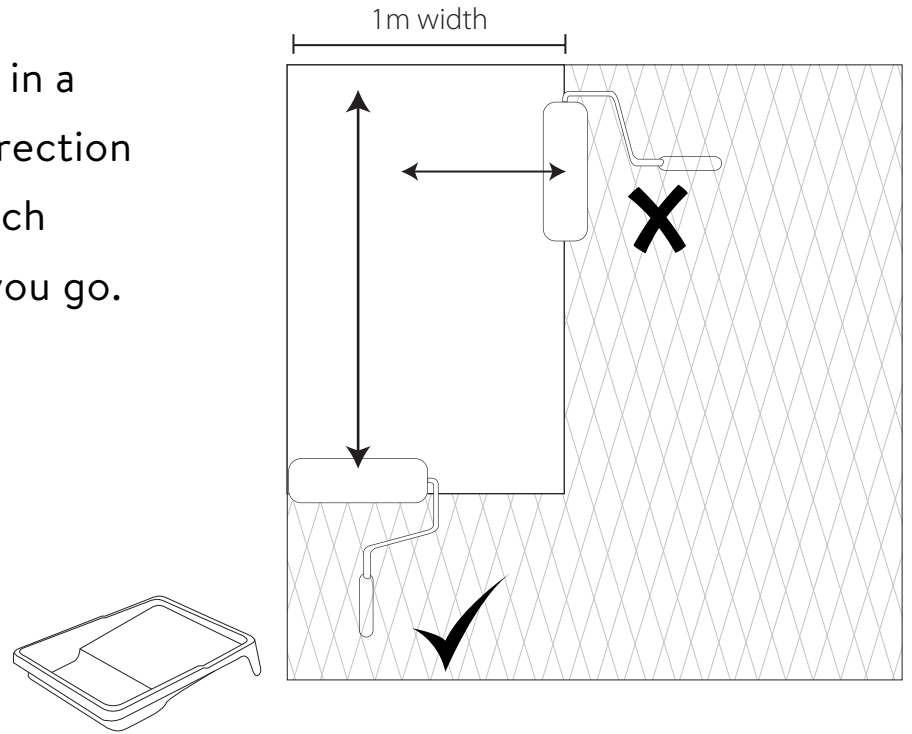

- Hairs
- Fibres
- Missed Spots

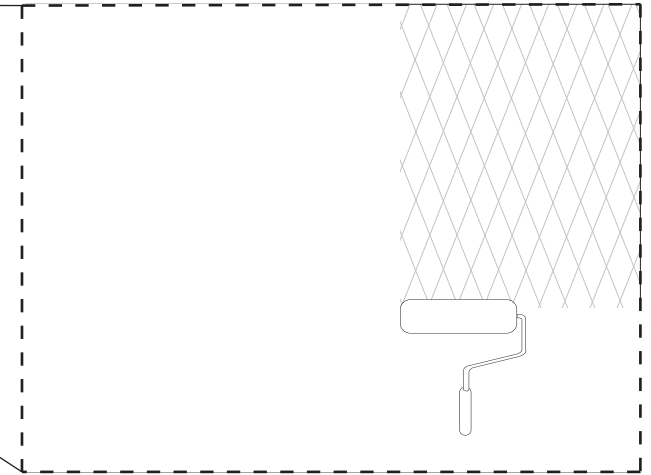

Step 7: Clean Up

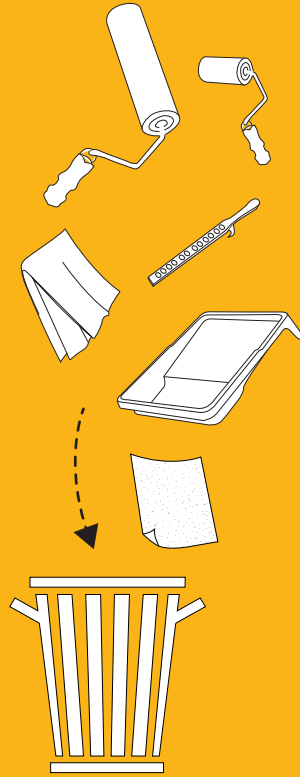
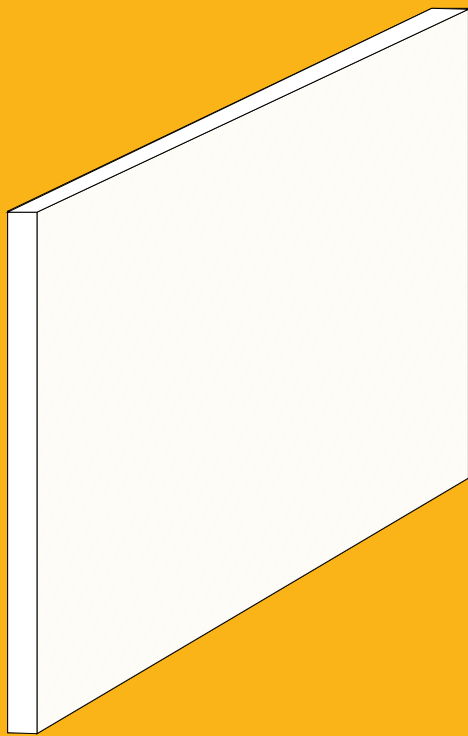

Process Comments

Remove tape before WBP dries completely. Allow paint to dry for 6 hours. Allow entire surface to cure for 5 days before use.

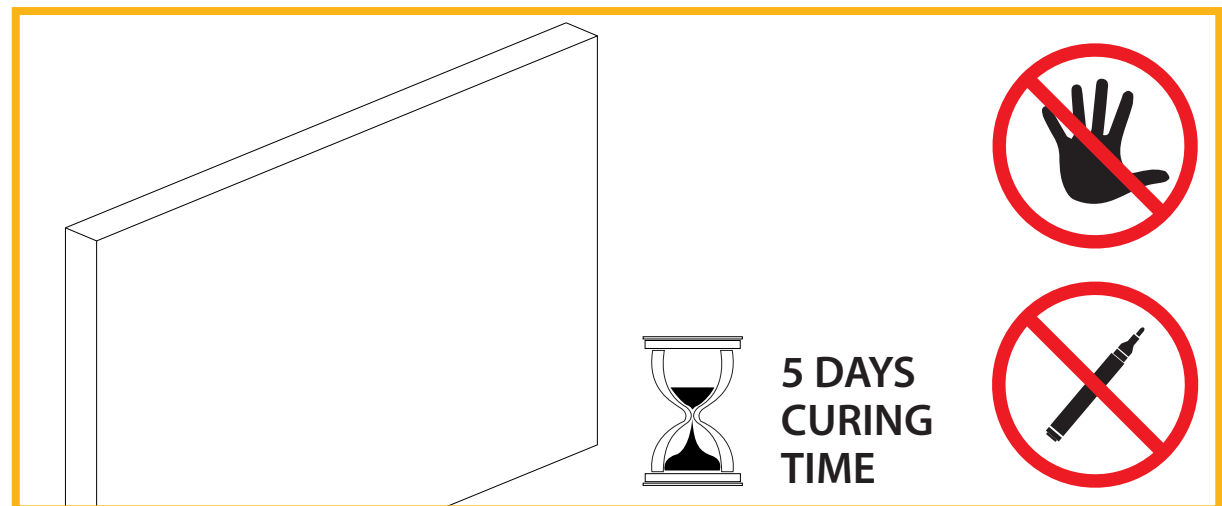
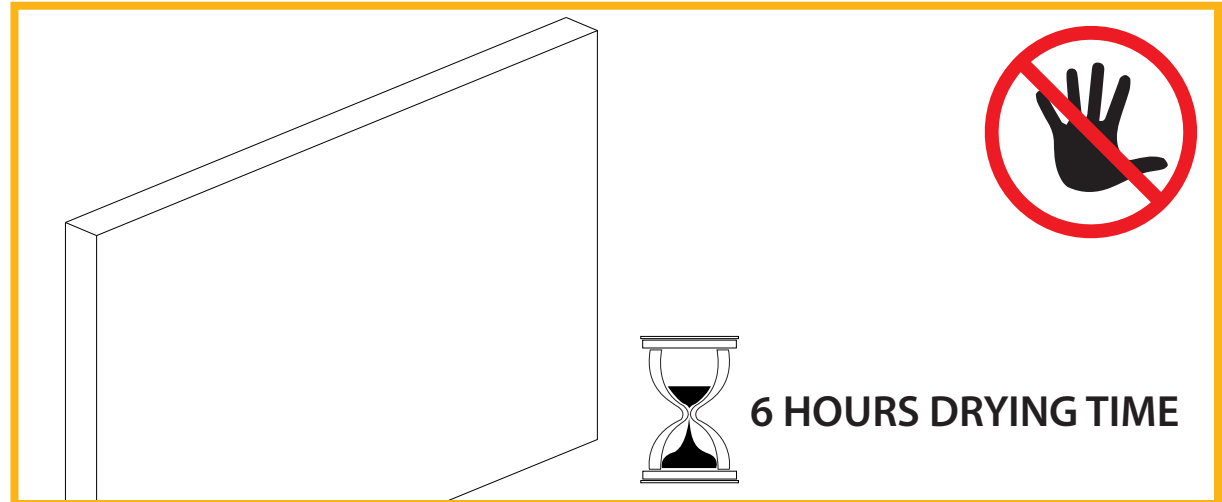

Step 8: Fitting Accessories

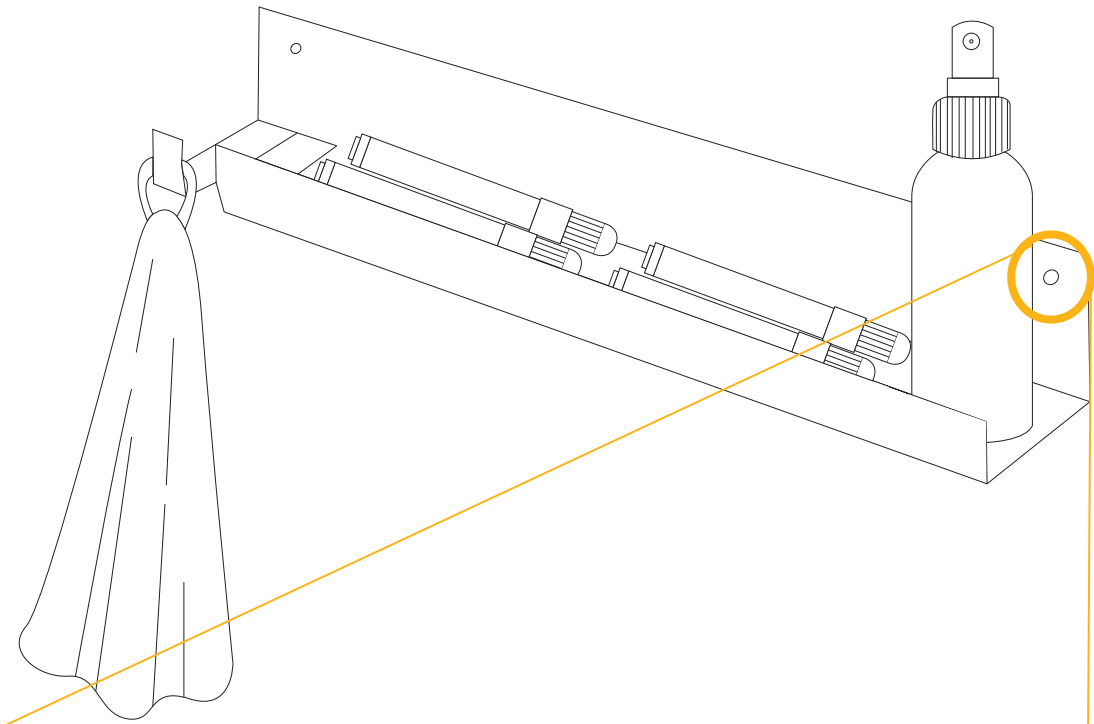
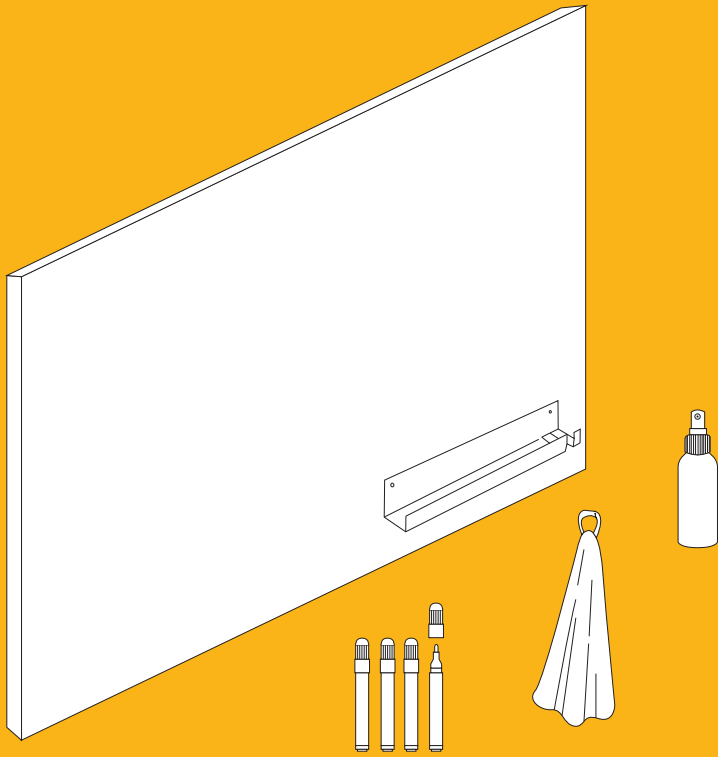

Process Comments

After curing is complete, install accessories and test the wall with the client.

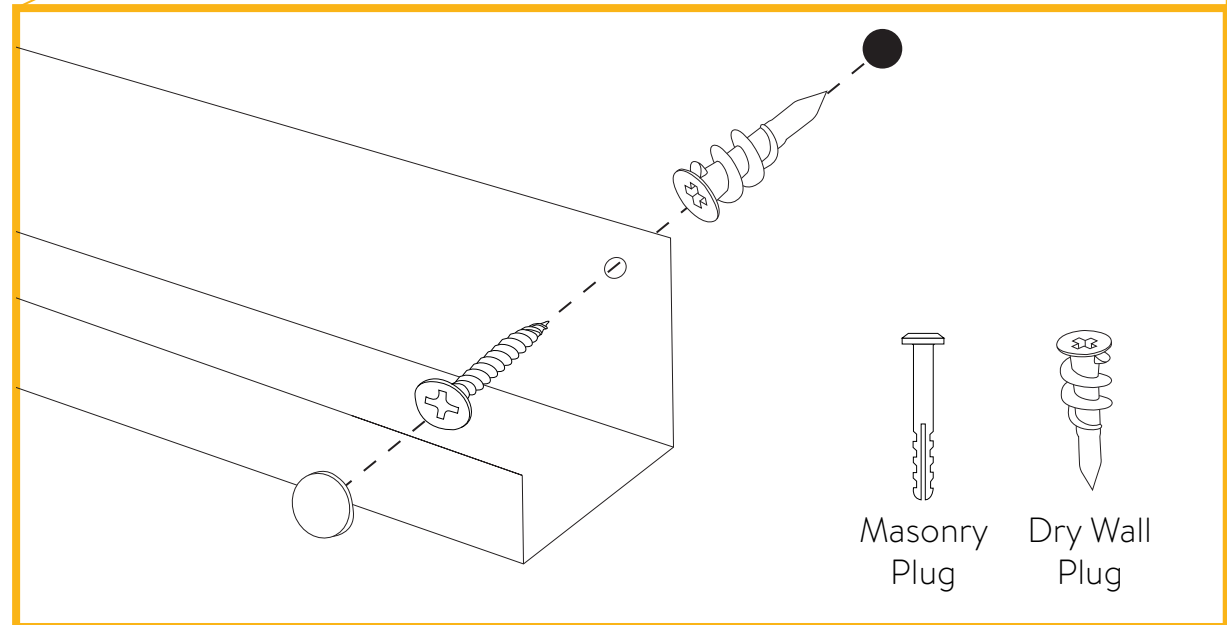

Step 9: Cleaning Guidelines

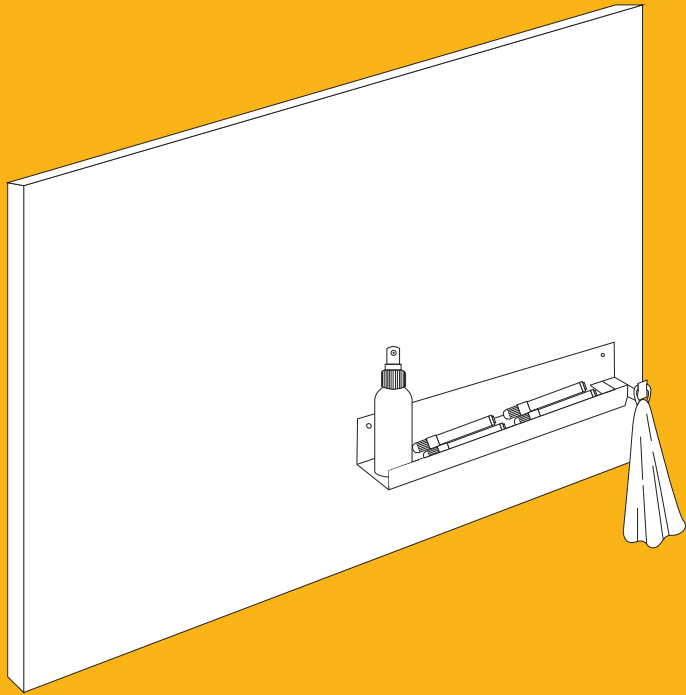

Process Comments

To ensure longevity and consistent performance of the Whiteboard Paint, follow these care guidelines

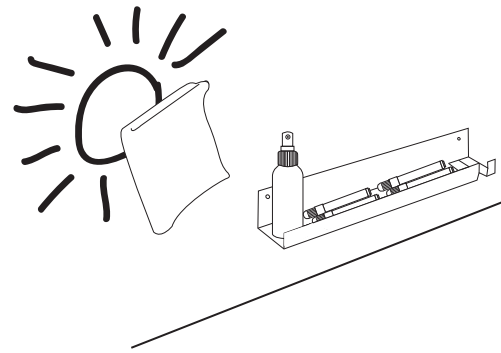

Use a dry microfibre cleaning cloth for day to day cleaning.

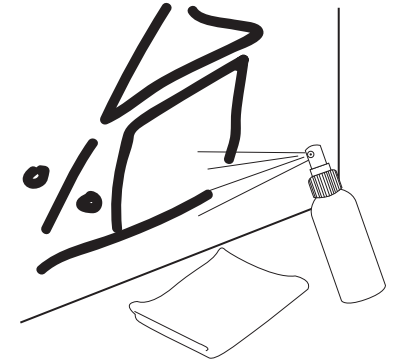

If ink has been on wall for an extended period of time, spray water on the ink, let sit to loosen the ink, and then wipe off.



For stubborn ink, use a blend of alcohol/water to help break down the ink.

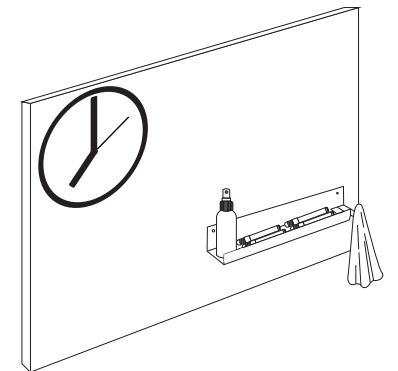

In heavy use environments, it is recommended to give the wall a deep clean periodically to prevent a build up of ink residue.

Step 10: Cleaning Warnings



Do not use any whiteboard cleaners

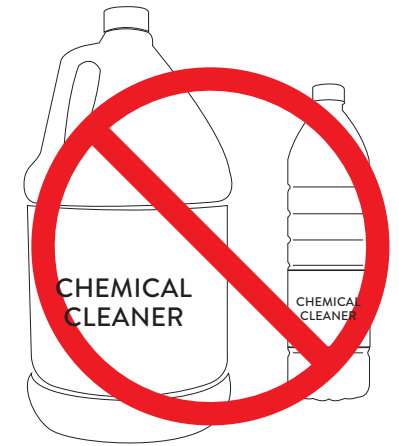

Do not use any chemical cleaners

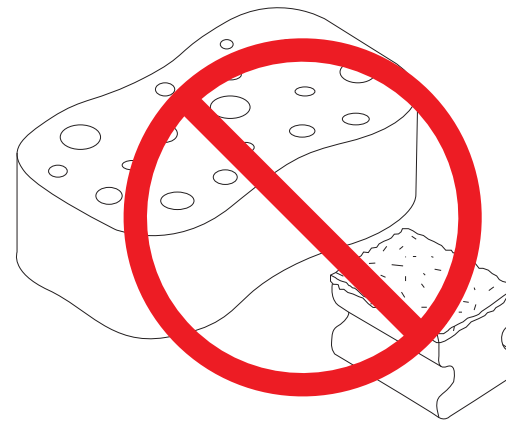

Do not use any abrasive cleaning clothes or brushes

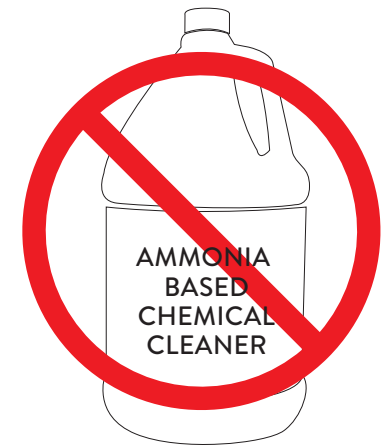

Do not use "ammonia" based cleaners on the wall

Process Comments

Avoid using any of the following as to avoid any damage to the Whiteboard Paint

Step 11: Preferred Markers

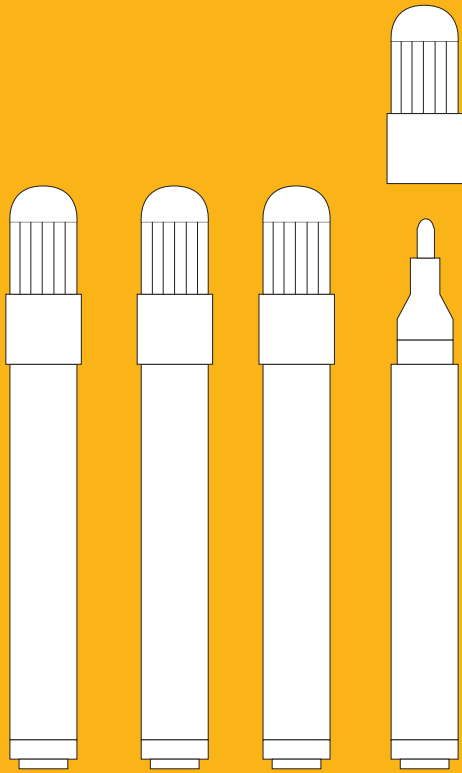

Process Comments

High quality recommended brands of markers suitable for Whiteboard Paint

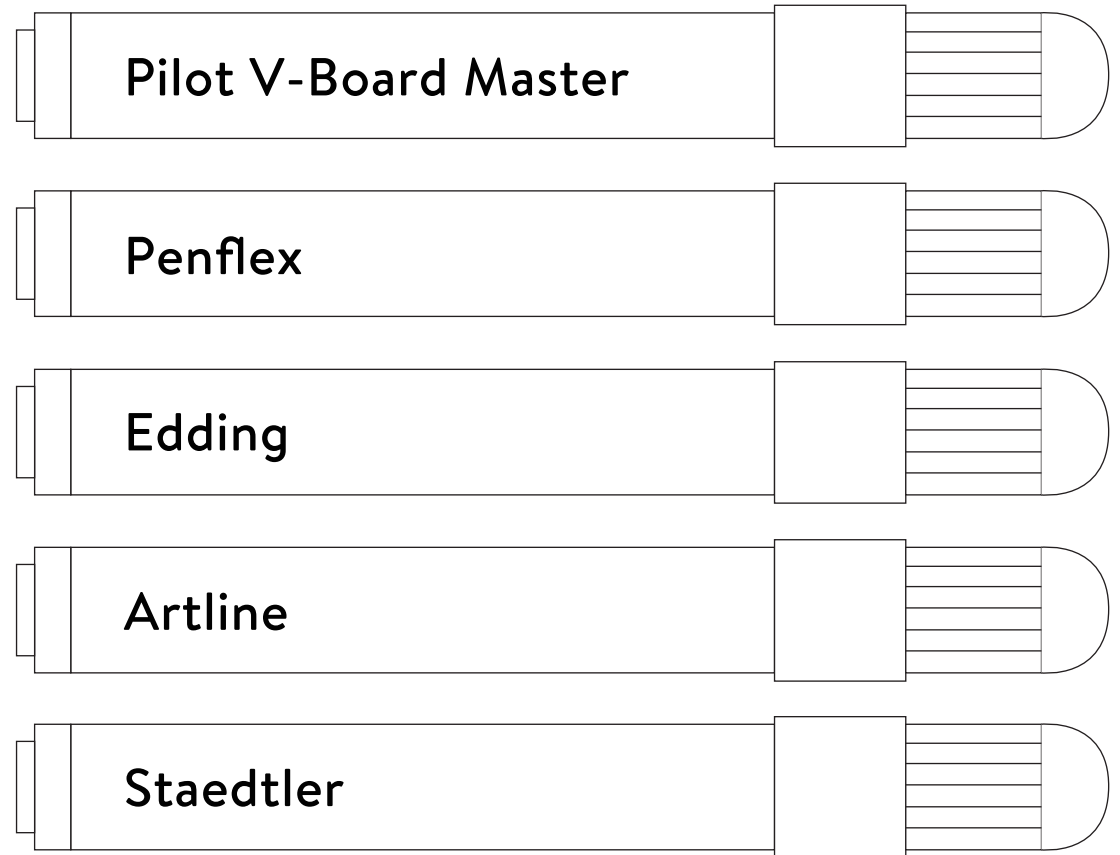

TIP

In the event that these brands are not available in your country, please contact us for guidelines on testing markers for Vicinity Whiteboard Paint

Step 12: Marker Warnings

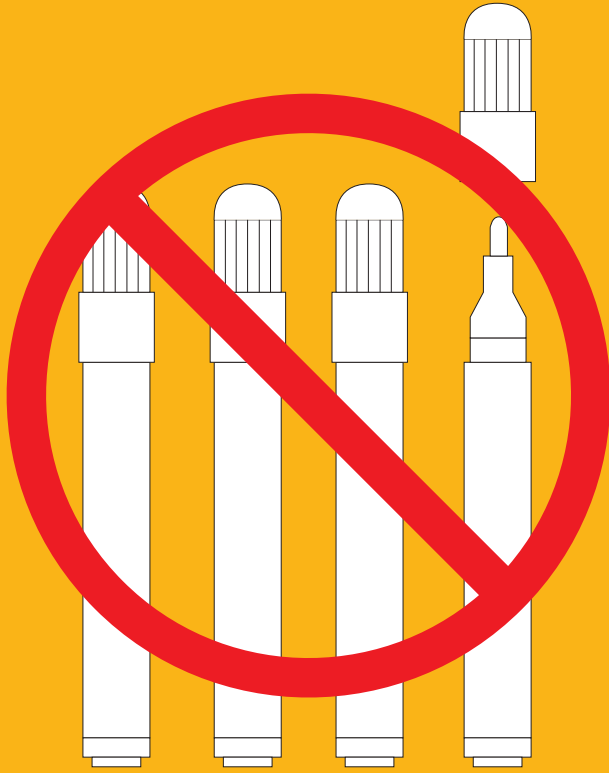

Process Comments

Avoid using any of the following to prevent damage to the Whiteboard Paint

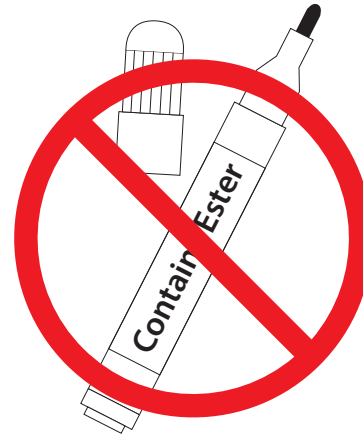

Do not use markers that have "Ester" in the chemical mix



Do not use permanent markers

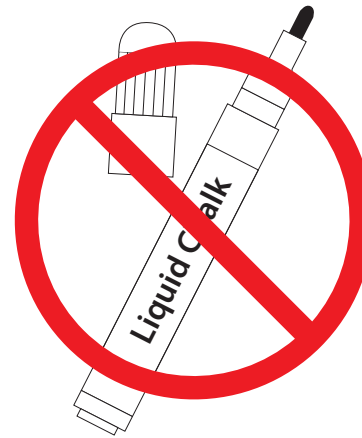

Do not use liquid chalk markers



Do not use dry erase crayons



VICINITY